

Post for freestanding installation

IHP

16970

SEG 85 701 39

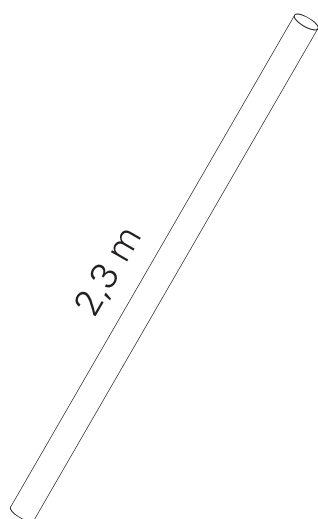

x1



x1



x1

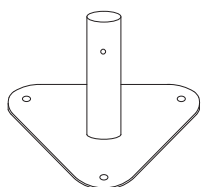

x1



x1

A

NOT INCLUDED

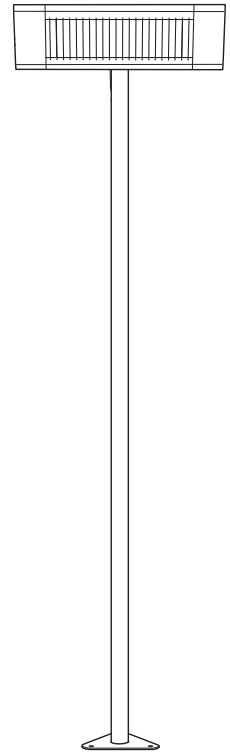
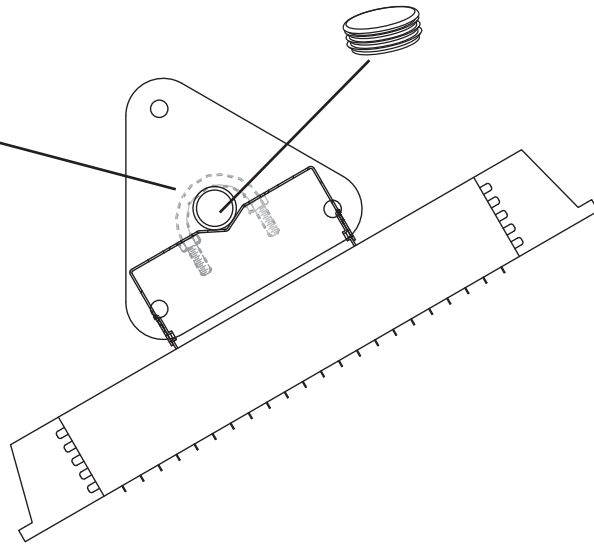
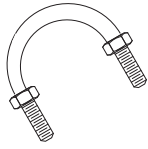

B

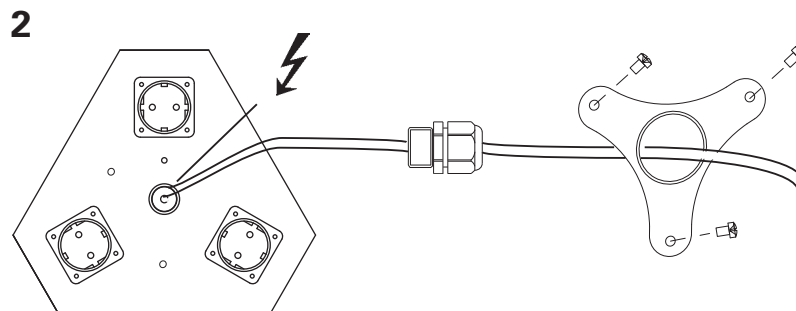
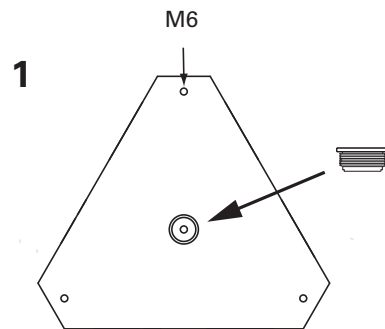
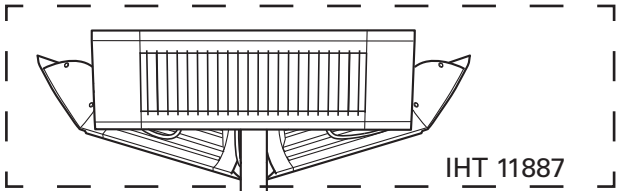

Main office

Frico AB
Box 102
SE-433 22 Partille
Sweden

Tel: +46 31 336 86 00
Fax: +46 31 26 28 25
mailbox@frico.se
www.frico.se

**For latest updated information and information
about your local contact: www.frico.se**